

# MBIS6036 Integral Skirted Tub

59.875" x 36" x 20"

## GENERAL SPECIFICATIONS:

**Tub Size** 59.875" x 36" x 20"  
**Bathing Well** length: 53" top / 42" bottom  
 width: 31.25" / 26.75" top  
 25.25" bottom  
 depth at overflow: 14.5"

**Plumbed Weight** 135 lbs / 61.2 kg  
**Soaker Weight** 115 lbs / 52.16 kg  
**Average Fill** 31 gal to above jet level  
**Maximum Fill** 61 gal to overflow

**Undermountable** No

NOTE: When sizing the water heater, tub capacity as well as other household uses should be considered. Filling this tub to the maximum level may require an above average size or dedicated water heater.

## ELECTRICAL SPECIFICATIONS:

**Required Electrical Service** 110 Volt  
**Air Bath or Whirlpool** 1-15 amp GFCI  
**Whirlpool with Inline Heater** 1-15 amp GFCI  
**Soaker with Inline Heater** 1-15 amp GFCI  
**Air Bath with Inline Heater** 2-15 amp GFCI

CSA Certified C/US; NAHB Certified; ANSI Z124.1 for plastic tubs and ANSI 112.19.7 for whirlpool components.

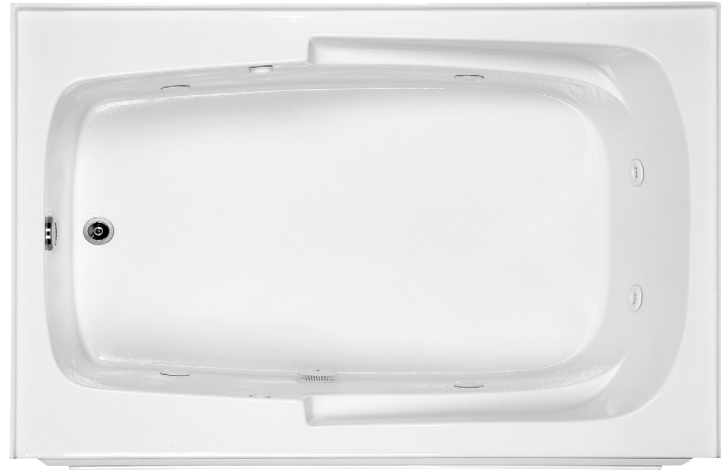

Features integral armrests.  
 Shown with Whirlpool Package.

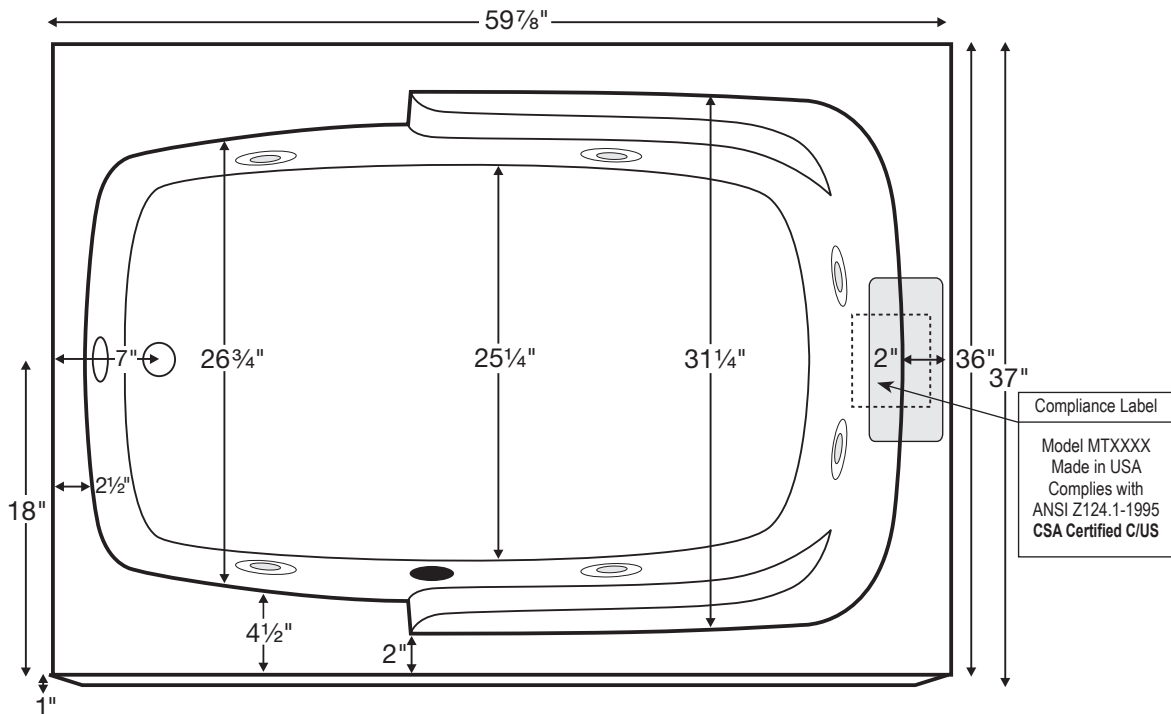

Shown with Whirlpool Package.

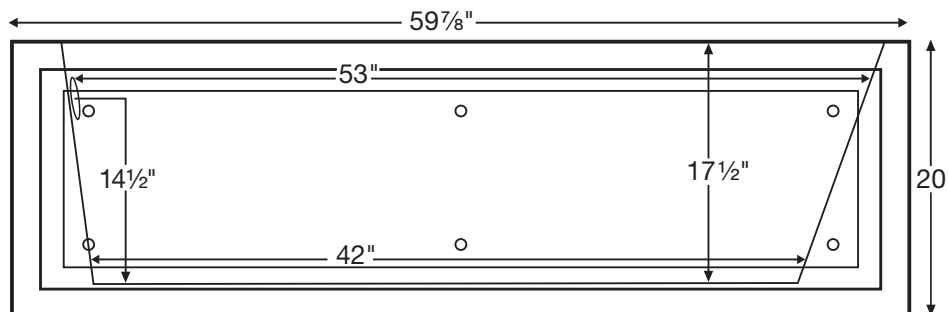

Before ordering or installing, please consider future access to equipment.

**INSTALLATION:** Measurements are  $\pm 1/2"$  and are subject to change without notice. Measurements herein supersede all others published prior to publication date shown below. Suction and control locations may vary. Specifications and configurations are subject to change without notice.



DESIGN YOUR EXPERIENCE™

**MBIS6036**  
**59.875" x 36" x 20"**

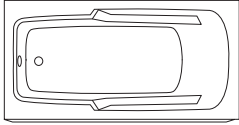
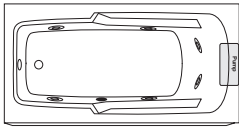
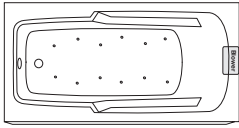
<b>Soaker</b>	<b>MBSIS6036</b>
	Soaker
	<b>\$785</b>
<b>Whirlpool</b>	<b>MBWIS6036</b>
	6 point-massage jets, 1 bhp pump
	<b>\$1,210</b>
<b>Air Bath</b>	<b>MBAIS6036</b>
	Twelve 6-port air jets (72 air streams), heated blower
Adds approximately 2"-3" to height	<b>\$1,710</b>

**COLORS**

**Standard:** White

**Color Upgrade:** Almond, Bone, Biscuit, Linen

N/C

\$30

**BATH OPTIONS**

• Quick Ship/Priority (priced per unit)	
Soaker or Whirlpool - 24 hours or less (QSHIPMTIS)	\$100
Air Bath - 72 hours or less (QSHIPMTISA)	\$200
• Inline Heater Installed	
Whirlpool (HTRMTIS)	\$310
Soaker or Air Bath (HTISOAK)	\$500
• Waste & Overflow Kits	
Lift & Turn Chrome (WOC)	\$60
Lift & Turn White (WOW)	\$100
Lift & Turn Brushed Nickel (WOBN)	\$160
• Whirlpool Trim Kits (Must be specified at the time of tub order)	
Chrome (TKCMTIS)	\$75
Brushed Nickel (TKBNMTIS)	\$95

**Important Information:**

- Whirlpools and Soakers ship within 3-5 working days.
- Air Baths ship within 7 working days.
- Local distributor may charge additional freight and/or residential delivery charges.
- Published prices are Manufacturer's Suggested Retail Price. See your local MTI dealer for best prices.

**MTI Distributor Multiplier Does Not Apply.**

**CONSTRUCTION AND STANDARD FEATURES**

**ALL INTEGRAL SKIRTED BATHS**

- Durable Lucite® high-gloss cross-linked cast acrylic.
- Bath reinforcement consisting of a thick layer of fiberglass/ titanium / resin, plus 1/2" metal reinforcement in all 4 sides.
- Leveled Foam Support System for more efficient installation. No need to use additional bedding compound.
- Integral tile flange on 3 sides.
- Left- or right-hand drain configuration (must specify when ordering).
- Front panel is removable for whirlpools and air baths.
- Textured bottom meets ASTM F-462-1994 slip resistance.
- 2-year residential warranty.

**ADDITIONAL FOR WHIRLPOOLS**

- Fully-adjustable point-massage jets.
- 1 bhp whisper-quiet pump with silent air volume control.

**ADDITIONAL FOR AIR BATHS**

- 3/4 bhp heated blower with an automatic purge cycle that dries the air system lines 20 minutes after use.
- Twelve 6-port low profile air jets (72 air streams) are installed on the tub floor with color-matching air caps.

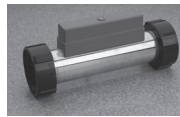

- **Inline Heater** (for whirlpools) - A 650-watt heater, activated by whirlpool pump, is designed to maintain water temperature at 102°F, not to heat cold water.

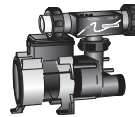

- **Inline Heater** (for soakers and air baths) - Water is drawn in through an intake and a 650-watt heater, then re-introduced into the bath through an output with negligible disturbance to the water. This system uses a re-circulating pump activated by an on/off switch.



Intake (shown) and output have the same appearance and are mounted on opposite sides of the tub.



- **Trim Kit** - Available for whirlpools. Includes jet escutcheons, on/off control, air-volume control and suction cover.