

MBRR6032E

59.25" x 31.75" x 18.5"

GENERAL SPECIFICATIONS:

Tub Size	59.25" x 31.75" x 18.5"
Bathing Well	length: 51" top / 42" bottom width: 25.75" / 21.5" top 20" bottom depth at overflow: 14"
Plumbed Weight	125 lbs / 56.75 kg
Soaker Weight	100 lbs / 45.40 kg
Average Fill	30 gal to above jet level
Maximum Fill	52 gal to overflow
Undermountable	No

NOTE: When sizing the water heater, tub capacity as well as other household uses should be considered. Filling this tub to the maximum level may require an above average size or dedicated water heater.

ELECTRICAL SPECIFICATIONS:

Required Electrical Service	110 Volt
Air Bath or Whirlpool	1-15 amp GFCI
Whirlpool with Inline Heater	1-15 amp GFCI
Soaker with Inline Heater	1-15 amp GFCI
Air Bath with Inline Heater	2-15 amp GFCI

CSA Certified C/US; NAHB Certified; ANSI Z124.1 for plastic tubs and ANSI 112.19.7 for whirlpool components.

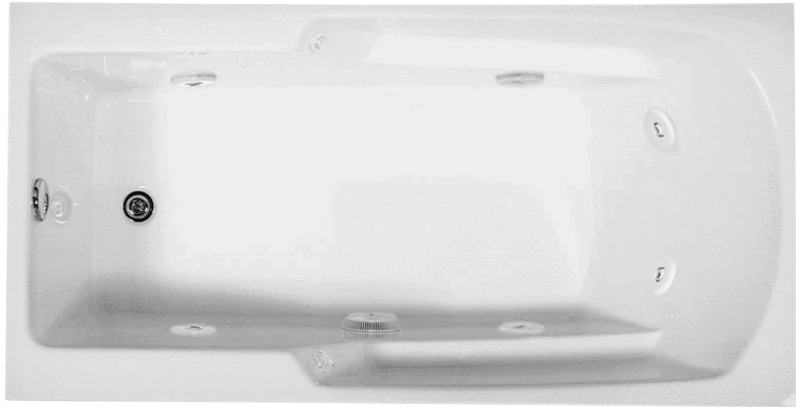

Features integral armrests.
Shown with Whirlpool Package.

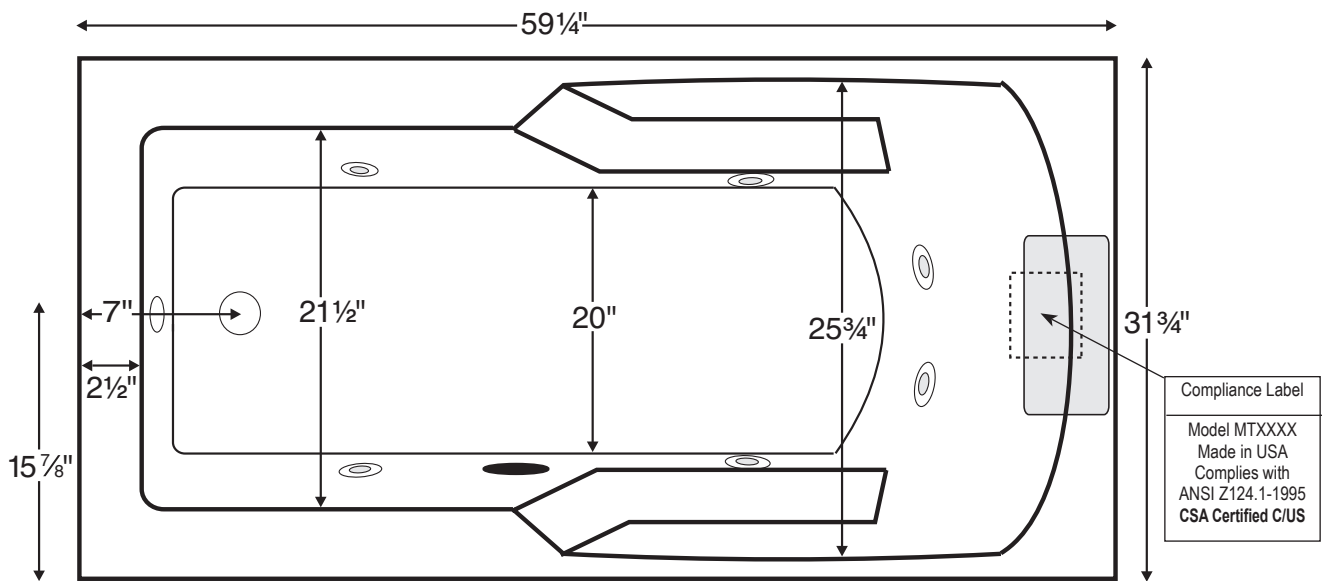

Compliance Label
Model MTXXXX
Made in USA
Complies with
ANSI Z124.1-1995
CSA Certified C/US

Shown with Whirlpool Package.

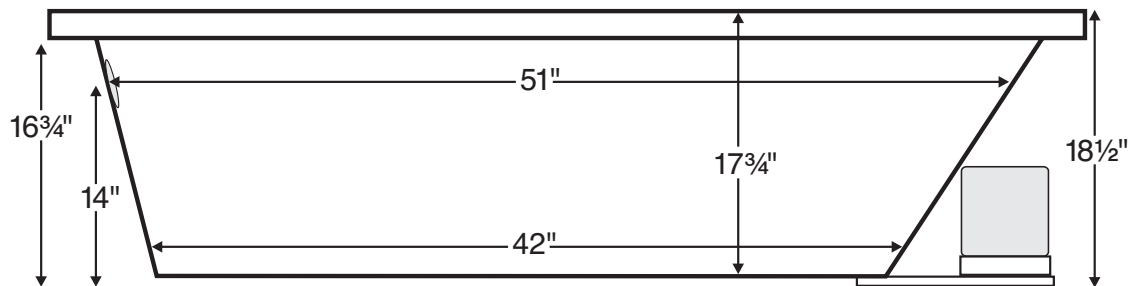

Before ordering
or installing,
please consider
future access
to equipment.

INSTALLATION: Add bedding compound to fully level and support bottom of tub. Skirting and/or pre-leveled frame will increase standard tub height up to 3". All tubs with pre-leveled foam base are designed to rest on the floor without additional bedding compound and will add approximately 2-3" to standard tub height. Please measure tub on-site before building tub decking. Measurements are $\pm 1/2"$ and are subject to change without notice. Measurements herein supersede all others published prior to publication date shown below. Suction and control locations may vary. Specifications and configurations are subject to change without notice.

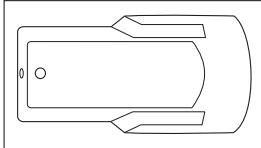
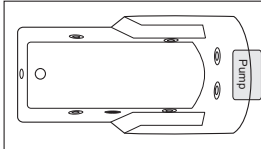
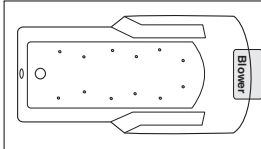

MBRR6032E
59.25" x 31.75" x 18.5"

Soaker	MBSRR6032E
	Soaker
	\$599
Whirlpool	MBWRR6032E
	6 point-massage jets, 1 bhp pump
	\$999
Air Bath	MBARR6032E
	Twelve 6-port air jets (72 air streams), heated blower and a pre-leveled foam base
Adds approximately 2"-3" to height	\$1,499

COLORS

Standard: White

Color Upgrade: Almond, Bone, Biscuit, Linen

N/C

\$30

BATH OPTIONS

- Quick Ship/Priority (priced per unit)
 - Soaker or Whirlpool - 24 hours or less (QSHIPMTIS) \$100
 - Air Bath - 72 hours or less (QSHIPMTISA) \$200
- Inline Heater Installed
 - Whirlpool (HTRMTIS) \$310
 - Soaker or Air Bath (HTISOAK) \$500
- Waste & Overflow Kits
 - Lift & Turn Chrome (WOC) \$60
 - Lift & Turn White (WOW) \$100
 - Lift & Turn Brushed Nickel (WOBN) \$160
- Tile Flange Kits (Must specify RH or LH drain)
 - Factory-Installed 1 side (TFK) \$110
 - Factory-Installed 2 sides (TFK2) \$120
 - Factory-Installed 3 sides (TFK3) \$140
 - Integral Tile Flange 3 sides (ITF) \$160
- Pre-Leveled Foam Base (PLFOAM) [standard with air baths] \$70
- Pre-Leveled Frame and Foam Base (PLF) \$275
- Skirting (note: MTI recommends a Pre-Leveled Frame when ordering a skirt)
 - Paintable Wood with Removable Raised Panels (SKW5) \$200
 - Acrylic Raised Panel-Look with Fixed Panels (SKAO5) \$250
 - Acrylic Raised Panel-Look with Removable Panels (SKAR5) \$350
- Whirlpool Trim Kits (Must be specified at the time of tub order)
 - Chrome (TKCMTIS) \$75
 - Brushed Nickel (TKBNMTIS) \$95

Important Information:

- Whirlpools and Soakers ship within 3-5 working days.
- Air Baths ship within 7 working days.
- Local distributor may charge additional freight and/or residential delivery charges.
- Published prices are Manufacturer's Suggested Retail Price. See your local MTI dealer for best prices.

MTI Distributor Multiplier Does Not Apply.

CONSTRUCTION AND STANDARD FEATURES

ALL BATHS

- Durable Lucite® high-gloss cross-linked cast acrylic.
- Bath reinforcement consisting of a thick layer of fiberglass / titanium / resin, plus 1/2" metal reinforcement in all sides of rectangular and corner tubs.
- Textured bottom meets ASTM F-462-1994 slip resistance.
- 2-year residential warranty.

ADDITIONAL FOR WHIRLPOOLS

- Fully-adjustable point-massage jets.
- 1 bhp whisper-quiet pump with silent air volume control.

ADDITIONAL FOR AIR BATHS

- 3/4 bhp heated blower with automatic purge that dries the air system lines 20 minutes after use.
- Twelve 6-port low profile air jets (72 air streams) are installed on the tub floor with color-matching air caps.
- Pre-leveled foam base.

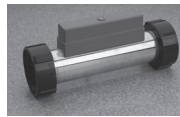

- **Inline Heater** (for whirlpools) - A 650-watt heater, activated by whirlpool pump, is designed to maintain water temperature at 102°F, not to heat cold water.

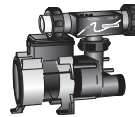

- **Inline Heater** (for soakers and air baths) - Water is drawn in through an intake and a 650-watt heater, then re-introduced into the bath through an output with negligible disturbance to the water. This system uses a re-circulating pump activated by an on/off switch.



Intake (shown) and output have the same appearance and are mounted on opposite sides of the tub.



Factory-Installed

- **Tile Flange Factory-Installed** - Rigid ABS material is bonded to the tub shell ensuring a water-tight installation between the tub deck and surrounding wall area.



Integral

- **Integral Tile Flange** - A 3/4" acrylic flange molded into the tub at the factory. Available only in a 3-sided flange for a rectangular tub and 2-sided flange for a corner tub.



- **Pre-Leveled Foam Base** - Facilitates installation by eliminating the need for bedding compound to level and support tub. Adds approximately 2-3" to overall tub height.



- **Pre-Leveled Frame** - Hardwood constructed frame simplifies the installation process. Includes high-density foam that supports the bottom of pre-leveled bath. (Shown with optional skirting attached)



- **Skirting** - For a cost effective finished appearance. Available in acrylic or paintable wood. Order skirting with a pre-leveled frame system to ensure proper fit and finish.



- **Trim Kit** - Available for whirlpools. Includes jet escutcheons, on/off control, air-volume control and suction cover.